

POWER RELAY

1 POLE - 1/3/5/10A Medium Load Control

LZ Series

■ FEATURES

- UL, CSA, SEV recognized
 - Contact rating types - Low level to 10 amps switching
 - Standard and high sensitivity types available
 - High surge strength version available
 - UL class B (130°C) insulation type available (only plastic sealed type)
 - Printed circuit terminals - 0.1" grid pitch
 - Plastic sealed type, RTIII
 - RoHS compliant.
- Please see page 9 for more information



■ PARTNUMBER INFORMATION

[Example] LZ - B 12 H M S E - K HV - UC
 (a) (b) (c) (d) (e) (f) (g) (h) (i) (j)

| | | | |
|-----|-----------------------|-------------------------------|---|
| (a) | Relay type | LZ | : LZ-Series |
| (b) | Coil wire class | Nil B | : Standard type : UL class B insulation type (130 °C) |
| (c) | Coil rated voltage | 12 | : 1.5.....100 VDC Coil rating table at page 3 |
| (d) | Contact type | Nil H V W | : 3A : 5A : 10A (standard coil power only) : 1A (bifurcated contact) |
| (e) | Contact configuration | Nil M | : 1 form C (SPDT) : 1 form A (SPST-NO) |
| (f) | Coil type | Nil S | : Standard type (450-600mW) : High sensitive type (300mW) |
| (g) | Contact material | Nil Nil Nil Nil E | : Gold overlay silver-palladium (1A) (only LZ-W) : Gold overlay silver-nickel (3A, 5A) : Silver cadmium oxide (10A) (LZ-V) : Silver tin oxide (10A) (LZ-VM) : Silver-nickel (3A, 5A) |
| (h) | Enclosure | Nil K C | : Flux proof type, RTII : Plastic sealed type (recommended for new designs) RTIII : Plastic sealed type (with tape) RTIII |
| (i) | Surge strength | Nil HV | : Standard type (4,000V) : High surge strength type (6,000V) |
| (j) | Approvals | UC | : UL, CSA approved type |

■ SPECIFICATION

LZ-() (Standard type)

| Item | | | 10A Type | 5A Type | 3A Type | 1A Type |
|--------------|-------------------------------------|--------------------|---|--|---|-------------------------------|
| | | | LZ - () V LZ - () VM | LZ - () H LZ - () HE | LZ - () LZ - () E | LZ- () W |
| Contact Data | Configuration | | 1 form A (SPST-NO), 1 form C (SPDT) | | | |
| | Construction | | Single | Single (crossbar) | | Bifurcated (crossbar) |
| | Material | | Silver cadmium oxide (LZ-V) Silver tin oxide (LZ-VM) | Gold overlay silver nickel, Silver nickel (LZ-HE, LZ-E) | | Gold overlay silver-palladium |
| | Resistance (initial) (at 6 VDC, 1A) | | Max. 100 mΩ | Max. 70 mΩ (LZ-H, LZ) Max. 100 mΩ (LZ-HE, E) | | Max. 50 mΩ |
| | Contact rating (resistive) | | 10A, 120VAC/24VDC 1/4hp, 120VAC | 5A, 120VAC/ 24VDC 1/8hp, 120VAC | 3A, 120VAC/ 30VDC 1/10hp, 120VAC | 1A, 120VAC / 30VDC |
| | Max. carrying current | | 10A | 5A | | 1A |
| | Max. switching voltage | | 250VAC, 150 VDC | | | |
| | Max. switching power | | 1,680VA, 240W | 960VA, 120W | 600VA, 90W | 190VA, 30W |
| | Max. switching current | | 10A | 5A | 3A | 1A |
| | Min. switching load * | | 100mA 5VDC | 10mA, 5VDC (LZ-H) 100mA, 5VDC (LZ-HE) | 10mA, 5VDC(LZ-) 100mA, 5VDC (LZ-E) | 0.1mA, 100mVDC |
| Life | Mechanical | | Min. 20 x 10 ⁶ operations | | | |
| | Electrical | | Min. 100 x 10 ³ operations (contact rating) | | | |
| Coil Data | Rated Power (at 20 °C) | | 450 - 600mW | | | |
| | Operate Power (at 20 °C) | | 170 - 220 mW (LZ - () V : 290 - 390 mW) | | | |
| | Operating temperature range | | -30 °C to +70 °C (no frost) | | | |
| Timing Data | Operate (at nominal voltage) | | Max. 7 ms (without bounce) | | | |
| | Release (at nominal voltage) | | Max. 4 ms (no diode) | | | |
| Insulation | Resistance (initial) | | Min. 250MΩ at 500VDC | | | |
| | Dielectric strength | Open contacts | 750VAC, 1min | | | |
| | | Contacts to coil | 2,000VAC, 1min | | | |
| | Surge strength | Coil to contacts | 4,000V / High surge: 6,000V, 1.2 x 50μs standard wave | | | |
| Other | Vibration resistance | Misoperation | 10 to 55Hz double amplitude 3.3 mm | | | |
| | | Endurance | 10 to 55Hz double amplitude 3.3 mm | | | |
| | Shock | Misoperation | Min. 100m/s ² (11 ± 1ms) | | | |
| | | Endurance | Min. 1,000m/s ² (6 ± 1ms) | | | |
| | Weight | Approximately 7.7g | | | | |

* Minimum switching loads mentioned above are reference values. Please perform the confirmation test with actual load before production since reference values may vary according to switching frequencies, environmental conditions and expected reliability levels.

■ SPECIFICATION

LZ-() S (High sensitive type)

| Item | | | 5A Type | 3A Type | 1A Type |
|-----------------------|------------------------------------|---|---|----------------------------|-------------------------------|
| | | | LZ-()HS, LZ-()HSE | LZ-()S, LZ-()SE | LZ-()WS |
| Contact Data | Configuration | | 1 form A (SPST-NO), 1 form C (SPDT) | | |
| | Construction | | Single (crossbar) | | Bifurcated (crossbar) |
| | Material | | Gold overlay silver nickel | Silver nickel (LZ-HSE, SE) | Gold overlay silver-palladium |
| | Resistance (initial) (at 6VDC, 1A) | | Max. 70mΩ (LZ-HS, S) Max. 100mΩ (LZ-HSE, SE) | | Max. 50mΩ |
| | Contact rating | Resistive | 5A, 120VAC / 24VDC | 3A, 120VAC / 30VDC | 1A, 120VAC / 30VDC |
| | | Motor load | 1/8 hp, 120VAC | 1/10 hp, 120VAC | - |
| | Max. carrying current | | 5A | | 1A |
| | Max. switching voltage | | 250VAC, 150 VDC | | |
| | Max. switching power | | 960VA, 120W | 600VA, 90W | 190VA, 30W |
| | Max. switching current | | 5A | 3A | 1A |
| Min. switching load * | | 10 mA, 5VDC (LZ-HS, S) 100 mA, 5VDC (LZ-HSE, SE) | | 0.1 mA, 100mVDC | |
| Life | Mechanical | | Min. 20 x 10 ⁶ operations | | |
| | Electrical | | Min. 100 x 10 ³ operations | | |
| Coil Data | Rated power (at 20 °C) | | 330 mW | | |
| | Operate power (at 20 °C) | | 140 mW | | |
| | Operating temperature range | | -30 °C to +80 °C (no frost) | | |
| Timing Data | Operate (at nominal voltage) | | Max. 7 ms | | |
| | Release (at nominal voltage) | | Max. 4 ms | | |
| Insulation | Resistance (initial) | | Min. 250MΩ at 500VDC | | |
| | Dielectric strength | Open contacts | 750VAC, 1min | | |
| | | Contacts to coil | 2,000VAC, 1min | | |
| | Surge strength | Coil to contacts | 4,000V / -HV type: 6,000V, 1.2 x 50μs standard wave | | |
| Other | Vibration resistance | Misoperation | 10 to 55Hz double amplitude 3.3 mm | | |
| | | Endurance | 10 to 55Hz double amplitude 3.3 mm | | |
| | Shock | Misoperation | Min. 100m/s ² (11 ± 1ms) | | |
| | | Endurance | Min. 1,000m/s ² (6 ± 1ms) | | |
| | Weight | Approximately 7.7 g | | | |

* Minimum switching loads mentioned above are reference values. Please perform the confirmation test with actual load before production since reference values may vary according to switching frequencies, environmental conditions and expected reliability levels.

■ COIL RATING

Standard type (450 mW)

| Coil Code | Rated Coil Voltage (VDC) | Coil Resistance +/- 10% (Ohm) | Must Operate Voltage (VDC) * | | Must Release Voltage (VDC) * | Rated Power (mW) |
|-----------|--------------------------|-------------------------------|---|--------------|------------------------------|------------------|
| | | | LZ-(B) () VM LZ-(B) () (M) (E) LZ-(B) () W (M) | LZ-(B) () V | | |
| 1.5 | 1.5 | 5 | 0.97 | 1.2 | 0.08 | 450 |
| 3 | 3 | 20 | 1.95 | 2.4 | 0.15 | |
| 5 | 5 | 56 | 3.25 | 4 | 0.25 | |
| 6 | 6 | 80 | 3.9 | 4.8 | 0.3 | |
| 9 | 9 | 180 | 5.85 | 7.2 | 0.45 | |
| 12 | 12 | 320 | 7.8 | 9.6 | 0.6 | |
| 18 | 18 | 720 | 11.7 | 14.4 | 0.9 | |
| 24 | 24 | 1,280 | 15.6 | 19.2 | 1.2 | |
| 48 | 48 | 3,800 | 28.8 | 38.4 | 2.4 | 600 |
| 100 | 100 | 22,200 | 65 | 80 | 5 | 450 |

High sensitive type (330 mW)

| Coil Code | Rated Coil Voltage (VDC) | Coil Resistance +/- 10% (Ohm) | Must Operate Voltage (VDC) * ¹ | Must Release Voltage (VDC) * ¹ | Rated Power (mW) |
|-----------|--------------------------|-------------------------------|---|---|------------------|
| 1.5 | 1.5 | 6.8 | 0.97 | 0.08 | 330 |
| 3 | 3 | 27 | 1.95 | 0.15 | |
| 5 | 5 | 80 | 3.25 | 0.25 | |
| 6 | 6 | 110 | 3.9 | 0.3 | |
| 9 | 9 | 250 | 5.85 | 0.45 | |
| 12 | 12 | 440 | 7.8 | 0.6 | |
| 18 | 18 | 990 | 11.7 | 0.9 | |
| 24 | 24 | 1,780 | 15.6 | 1.2 | |

Note: All values in the table are valid for 20°C and zero contact current.

* Specified operate values are valid for pulse wave voltage.

■ SAFETY STANDARDS

| Type | Compliance | Contact rating |
|------|--------------------------|---|
| UL | UL 508 | Flammability: UL 94-V0 (plastics) |
| | E 56140, E 45026 | [LZ-()W, LZ-()WS] 0.8A, 240VAC (resistive) |
| CSA | C22.2 No. 14 LR 35579 | 1A, 120VAC / 30VDC (resistive) |
| | | [LZ-(), LZ-()S] 2.5A, 240 VAC (resistive) |
| | | 3A, 120 VAC / 30VDC (resistive) |
| | | 1/10hp, 120VAC/240VAC Pilot duty: D150 |
| | | [LZ-()H, LZ-()HS] 4A, 240 VAC (resistive) |
| | | 5A, 30 VAC resistive |
| | | 1/10 HP, 120VAC/240VAC Pilot duty: D150 |
| | | [LZ-()V] 7A, 240 VAC (resistive) |
| | | 10A, 120 VAC / 30VDC (resistive) |
| | | 1/4hp, 120VAC/240VAC |

Also complies with SEV.

CHARACTERISTIC DATA

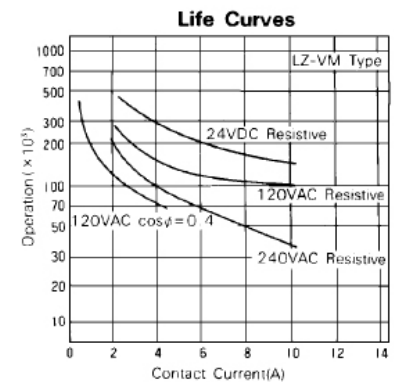
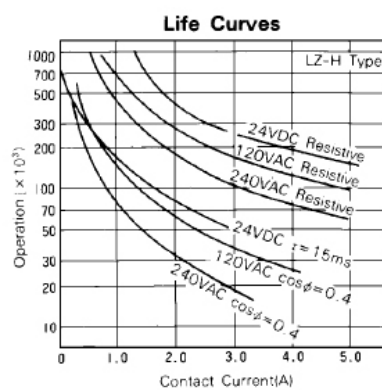
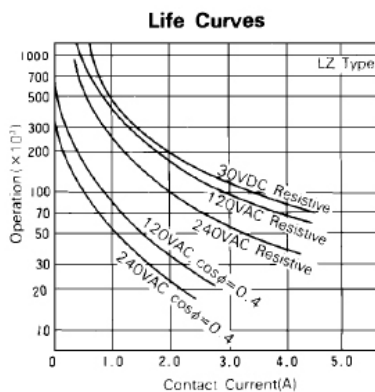
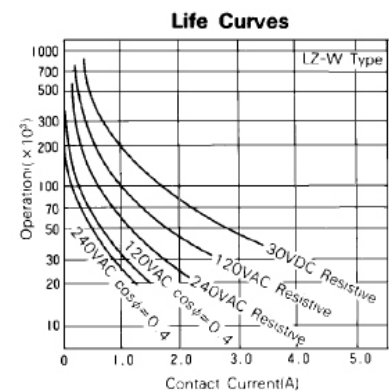
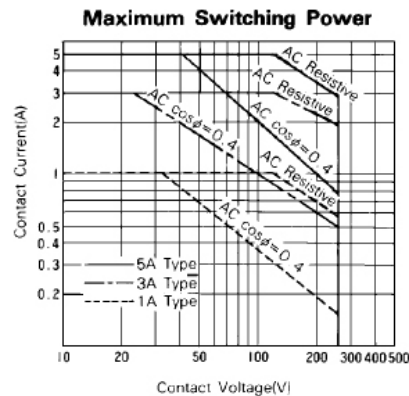
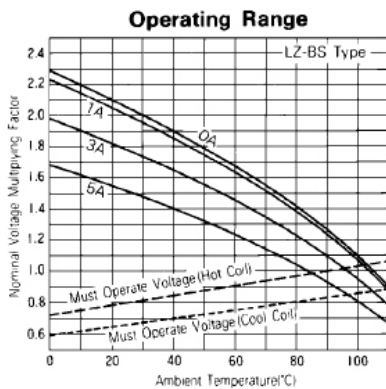
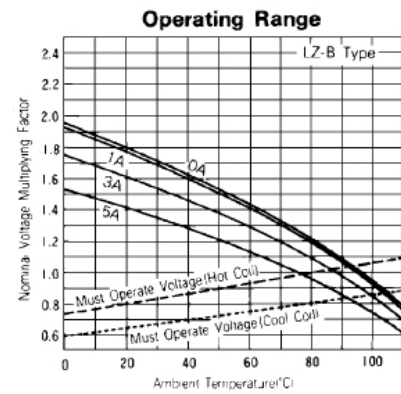
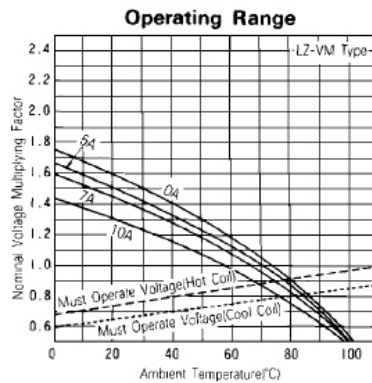
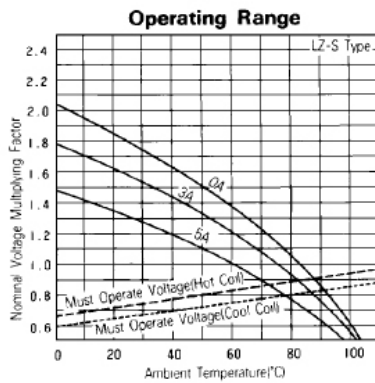
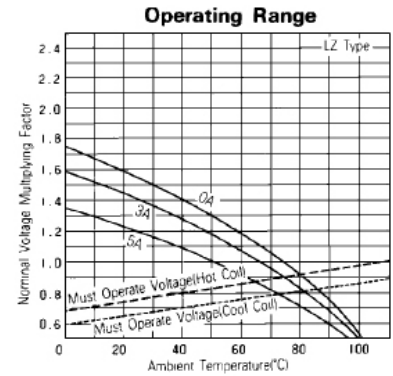
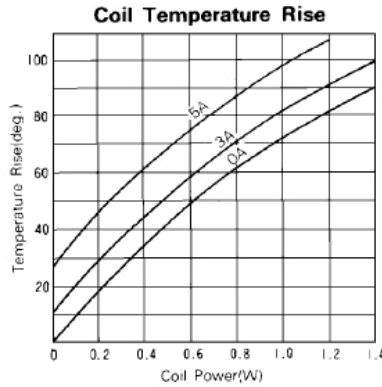
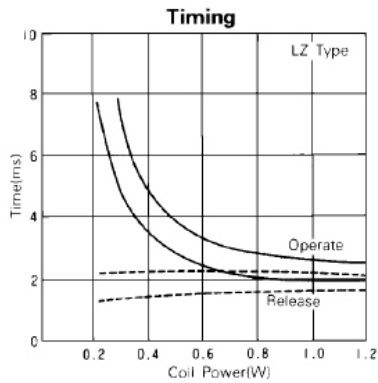

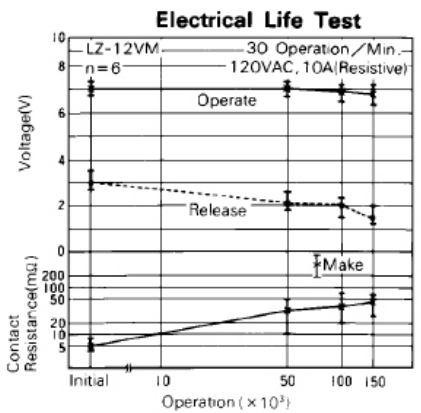
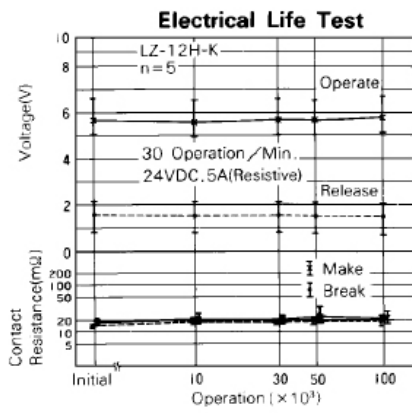
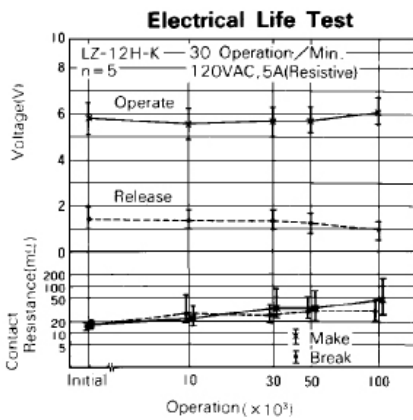
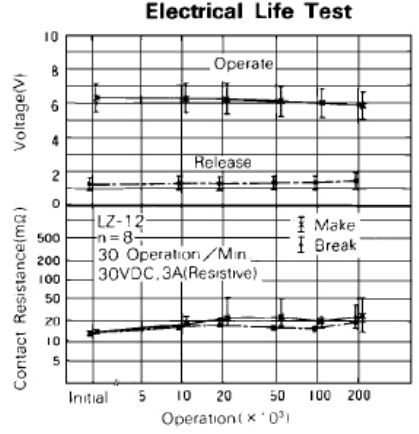
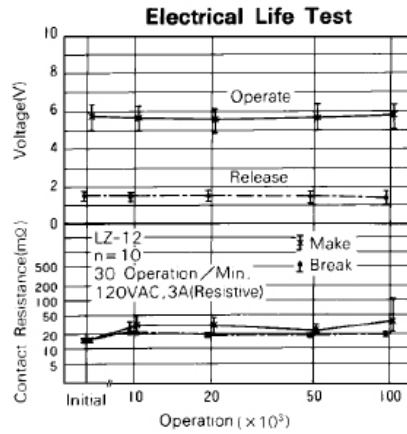
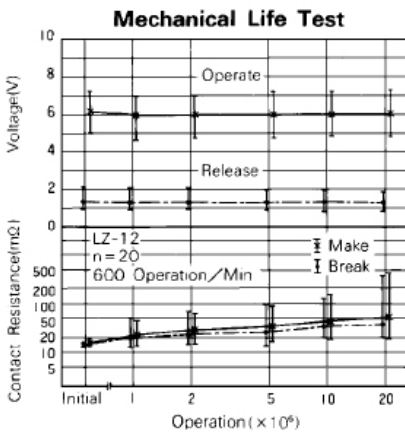
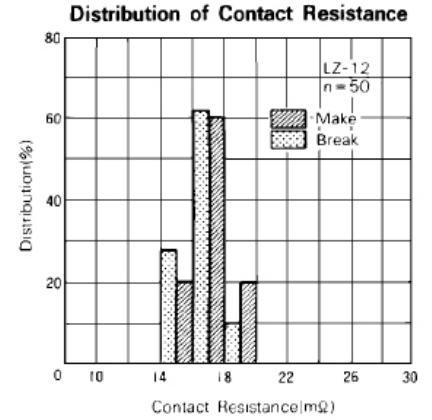
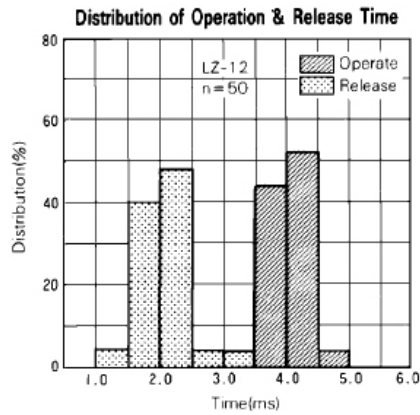
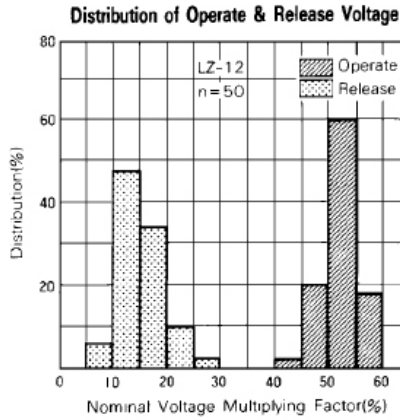

■ DIMENSIONS

● Dimensions

LZ-M type (Flux proof type)

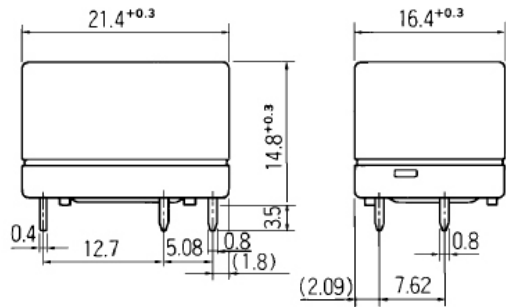

● Schematics

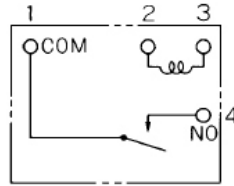

● PC board mounting hole layout (BOTTOM VIEW)

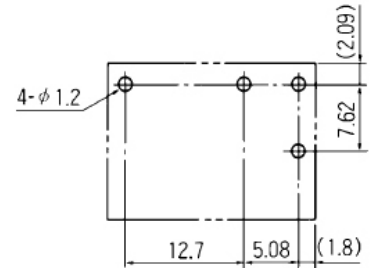

LZ-M-K, LZ-M-C type (Plastic sealed type or sealed with tape)

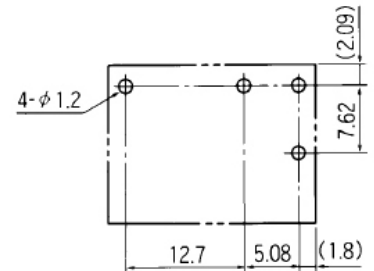
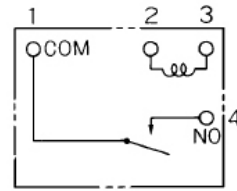
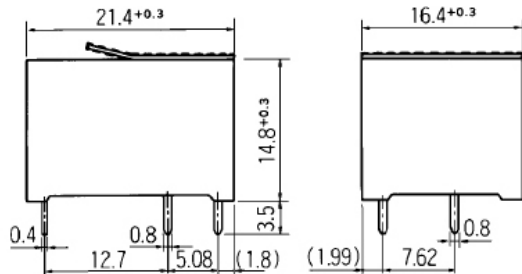

Dotted line: Seal tape (LZ-M-C type)

LZ type (Flux proof type)

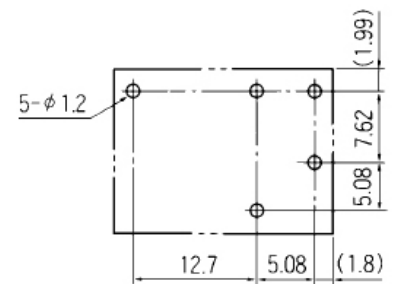
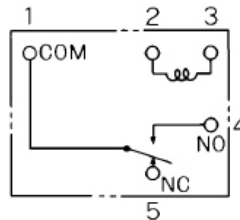
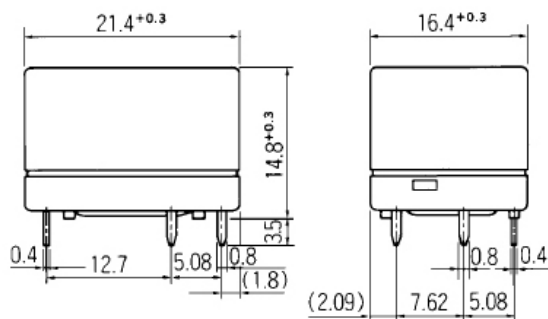

LZ-K, LZ-C type (Plastic sealed type or sealed with tape)

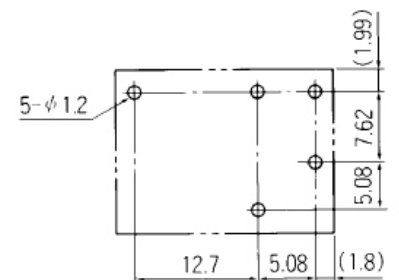
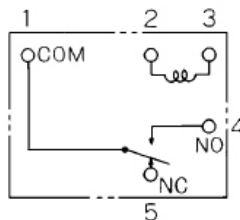
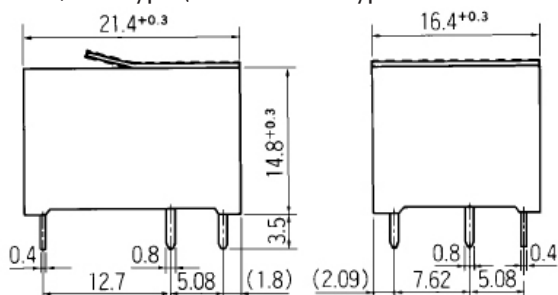

Dotted line: Seal tape (LZ-C type)

RoHS Compliance and Lead Free Information

1. General Information

- All relays produced by Fujitsu Components are compliant with RoHS directive 2011/65/EU including amendments.
- Cadmium as used in electrical contacts is exempted from the RoHS directives. As per Annex III of directive 2011/65/EU.
- All relays are lead-free. Please refer to Lead-Free Status Info for older date codes at: <http://www.fujitsu.com/downloads/MICRO/fcai/relays/lead-free-letter.pdf>
- Lead free solder plating on relay terminals is Sn-3.0Ag-0.5Cu, unless otherwise specified. This material has been verified to be compatible with PbSn assembly process.

2. Recommended Lead Free Solder Condition

- Recommended solder Sn-3.0Ag-0.5Cu.

Flow Solder Condition:

Pre-heating: maximum 120°C within 90 sec.
 Soldering: dip within 5 sec. at 255°C ± 5°C solder bath
 Relay must be cooled by air immediately after soldering

Solder by Soldering Iron:

Soldering Iron 30-60W
 Temperature: maximum 350-360°C
 Duration: maximum 3 sec.

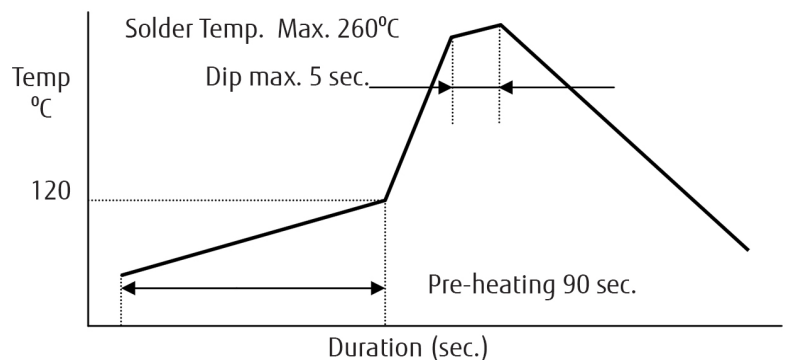

We highly recommend that you confirm your actual solder conditions

3. Moisture Sensitivity

- Moisture Sensitivity Level standard is not applicable to electromechanical relays, unless otherwise indicated.

4. Tin Whiskers

- Dipped SnAgCu solder is known as presenting a low risk to tin whisker development. No considerable length whisker was found by our in house test.

Fujitsu Components International Headquarter Offices

| | | |
|---|--|--|
| <p>Japan Fujitsu Component Limited Shinagawa Seaside Park Tower 19F, 12-4, Higashi-shinagawa 4-chome, Shinagawa-ku, Tokyo, 140-0002, Japan Tel: (81-3) 3450-1681 Fax: (81-3) 3474-2385 Email: fcl-contact@cs.jp.fujitsu.com Web: www.fcl.fujitsu.com</p> | <p>Europe Fujitsu Components Europe B.V. Diamantlaan 25 2132 WV Hoofddorp Netherlands Tel: (31-23) 5560910 Fax: (31-23) 5560950 Email: info@fceu.fujitsu.com Web: www.fujitsu.com/uk/components</p> | <p>China Fujitsu Electronic Components (Shanghai) Co., Ltd. Unit 4306, InterContinental Center 100 Yu Tong Road, Shanghai 200070, China Tel: (86-21) 3253 0998 Fax: (86-21) 3253 0997 Email: fcal@sg.fujitsu.com Web: www.fujitsu.com/sg/products/devices/components/</p> |
| <p>North and South America Fujitsu Components America, Inc. 2290 North 1st Street, Suite 212 San Jose, CA 95131, USA Tel: (1-408) 745-4900 Fax: (1-408) 745-4970 Email: components@us.fujitsu.com Web: us.fujitsu.com/components</p> | <p>Asia Pacific Fujitsu Components Asia Ltd. 102E Pasir Panjang Road #01-01 Citilink Warehouse Complex Singapore 118529 Tel: (65) 6375-8560 Fax: (65) 6273-3021 Email: fcal@sg.fujitsu.com Web: www.fujitsu.com/sg/products/devices/components/</p> | <p>Hong Kong Fujitsu Components Hong Kong Co., Ltd. Unit 506, Inter-Continental Plaza No.94 Granville Road, Tsim Sha Tsui, Kowloon, Hong Kong Tel: (852) 2881-8495 Tex: (852) 2894-9512 Email: fcal@sg.fujitsu.com Web: www.fujitsu.com/sg/products/devices/components/</p> |

©2015 Fujitsu Components Europe B.V. All rights reserved. All trademarks or registered trademarks are the property of their respective owners.

The contents, data and information in this datasheet are provided by Fujitsu Component Ltd. as a service only to its user and only for general information purposes.

The use of the contents, data and information provided in this datasheet is at the users' own risk.

Fujitsu has assembled this datasheet with care and will endeavor to keep the contents, data and information correct, accurate, comprehensive, complete and up to date.

Fujitsu Components Europe B.V. and affiliated companies do however not accept any responsibility or liability on their behalf, nor on behalf of its employees, for any loss or damage, direct, indirect or consequential, with respect to this datasheet, its contents, data, and information and related graphics and the correctness, reliability, accuracy, comprehensiveness, usefulness, availability and completeness thereof.

Nor do Fujitsu Components Europe B.V. and affiliated companies accept on their behalf, nor on behalf of its employees, any responsibility or liability for any representation or warrant of any kind, express or implied, including warranties of any kind for merchantability or fitness for particular use, with respect to these datasheets, its contents, data, information and related graphics and the correctness, reliability, accuracy, comprehensiveness, usefulness, availability and completeness thereof. Rev. October 29, 2015